

**Features**

- 25" (635) x 22" (559) x 8" (203) top mount kitchen sink.
- Single compartment.
- 18 gauge 304 stainless steel.
- Center drain location.
- Brushed finish.
- Superior undercoating for added sound insulation.
- 3mm sound deadening pads on all 4 sink sides and bottom. Up to 3 times heavier than competitive models.
- Fits 30" base cabinet width.

**Components**

Product includes:  
Cutout Template  
Installation Hardware  
Installation Instructions

**Options**

- TSGC25221 Stainless Steel Bottom Sink Grid Set
- TCBC2116 Bamboo Cutting Board
- 2210R Covered Sink Strainer
- 4010 Covered Disposer Strainer

**Warranty**

- Lifetime Limited Warranty

**Specified Model**

| Model              | CTSB25228  |
|--------------------|--|
| Overall Dimensions | L25" x W22 <sup>1</sup> / <sub>4</sub> " x D8"<br>635 x 559 x 203                                |
| Bowl Dimensions    | L20 <sup>6</sup> / <sub>16</sub> " x W15 <sup>3</sup> / <sub>16</sub> " x D8"<br>533 x 394 x 229 |
| Drain holes:       | 3 <sup>5</sup> / <sub>8</sub> " (92mm)   |
| Shipping Weight    | 15 lbs.  |
| Material           | 18 gauge 304 stainless steel   |
| Installation       | counter top mounted  |
| Required           | template, included   |

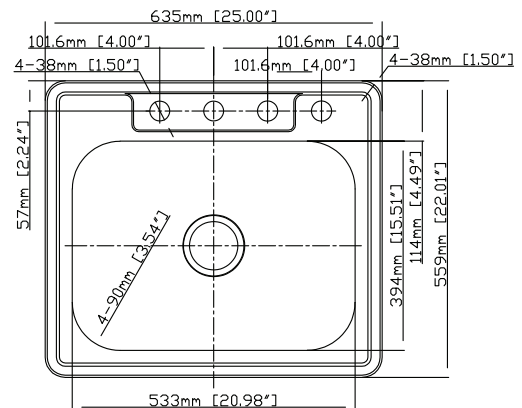
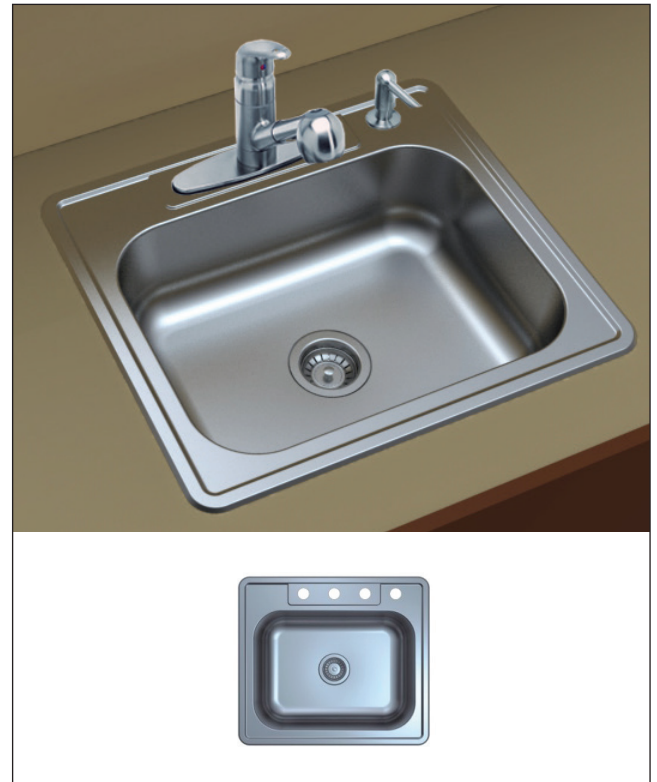

**To Be Specified:**

see back for configurations available for this sink

| Faucet Hole Drillings    |               |
|--------------------------|---------------|
| <input type="checkbox"/> | 1 Hole        |
| <input type="checkbox"/> | 2 Holes       |
| <input type="checkbox"/> | 2 Holes - MR2 |
| <input type="checkbox"/> | 3 Holes       |
| <input type="checkbox"/> | 4 Holes       |
| <input type="checkbox"/> | 5 Holes       |

**Codes/Standards**

ASME A112.19.3/CSA B45.4

**Notes**

Install this product according to the installation instructions.

**Faucet Hole Configurations available for this sink model**

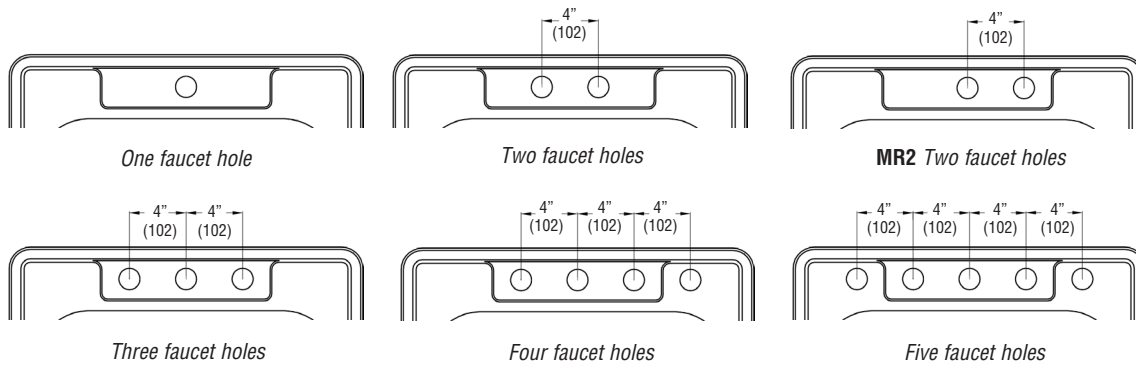

**Optional Accessories**

TSGC25221 Bottom Sink Grid

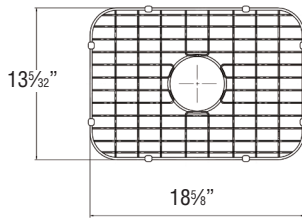

2210R Covered Flip Top Sink Strainer.

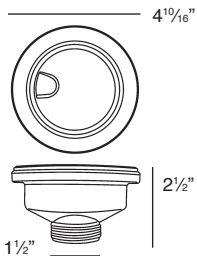

Water drains easily when cover is in place. Cover flips up with easy touch. Cover makes a flat surface at the sink bottom that prevents food waste from getting into the strainer basket for easy sink clean up. Polypropylene housing. Fits standard 3 1/2" opening.

2310 Remote Covered Flip Top Sink Strainer.

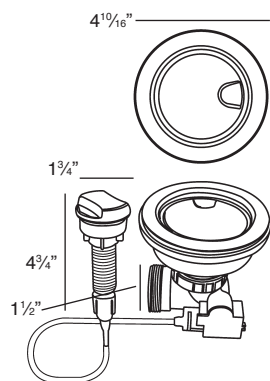

Turn the remote knob to open and close drain. Water drains easily when cover is in place. Cover flips up with easy touch. Cover makes a flat surface at the sink bottom that prevents food waste from getting into the strainer basket for easy sink clean up.

Polypropylene housing. Fits standard 3 1/2" opening. 1 3/8" hole required in countertop for remote installation. Remote cable 25 1/2" L.

4010 Covered Flip Top Disposer Strainer.

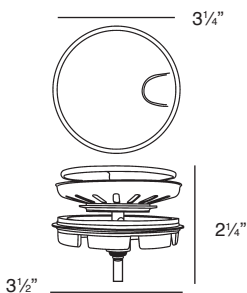

Water drains easily when cover is in place. Cover flips up with easy touch. Polypropylene housing. Top mount installation for 3 1/2" opening.